

Quality
&
Efficiency



PXFLOW[®]
PUMPS SERVICE & ENGINEERING



[We supply clean water and remove waste water]

QUALITY WHICH REDUCES PUMPING COSTS

For over 50 years, PAPANATONATOS S.A. has focused on the customer's design, manufacturing and service needs in the field of submersible pumps. Our engineering department has acquired invaluable technical knowledge throughout our long and close collaboration, as a customer and a supplier, with some of the leading global pump manufacturing companies. This extensive technical experience has significantly contributed to our success as a pump manufacturer. We are currently offering some of the most robust and energy efficient pump units in the market that are perfectly adapted to all sorts of difficult operating conditions in clean water and wastewater pumping applications. We are working according to the ISO 9001:2000 norms certificate from TUV since May 2000. Our well organized company-owned facilities utilize contemporary CNC (Computer Numerical Controlled) lathes and milling equipment for the machining of our motor cast parts and pump components that are produced in our foundry. Our design department utilizes some of the most advanced 3D-CAD (Computer Aided Design) programs in order to materialize with great accuracy the

most efficient pump designs. We have carefully chosen to equip our pumps with motors and standard parts made by some of the leading motor manufacturers in the European Union such as Pleuger, Siemens and Franklin that are in full accordance with the latest manufacturing and environmental standards. Finally all of our pumps from both family lines, (PXFLOW and FLOWPAP), are meticulously tested in our modern test stand where crucial technical data is collected and recorded before the pumps are released for dispatch to the customer.



ALL SUBMERSIBLE PUMPS IN ONE PROGRAM SELECTION

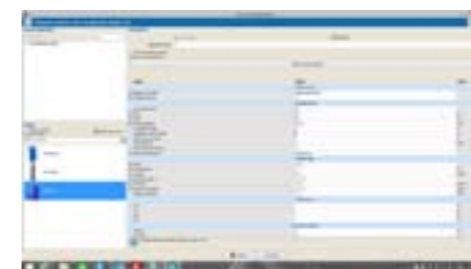

FLOW-select is a special program and an indispensable tool for all pump consulting engineers and users. Both pump family names, (FLOWPAP clean water submersible pumps and PXFLOW waste water submersible pumps), are included in the program.

If the basic planning data such as capacity and total head are available, the Flow-select can suggest different pump types from both pump family names. If the data is not available Flow-select provides a simple friction loss calculator that can still aid the user to choose the correct pump unit.

Other FLOW select advantages:

- User friendly interface translated in 21 languages
- Easy unit conversion.
- 50-60Hz (where applicable)
- Impeller trimming
- Variable curve speed (for applications with inverter)
- Combination curve characteristics with friction loose curve.



PXFLOW
sewage pumps



DESIGN FEATURES

All **PXFLOW** pumps are designed and built tough to the highest industrial specifications up to date and are equipped with a number of operation/maintenance friendly features.

Only the very best features come as a standard in **PXFLOW** pumps.

PXFLOW code system

- No of poles
- Motor power P2 Kw (50Hz)
Hp (60Hz)
- Motor series
- Impeller code
- Impeller type V=Vortex, C=Channel
- Pump volute code
- Volute outlet size
- Pump series for waste water

ex. PX3-150.0 VX3-150+ M3.1D-18,5/4

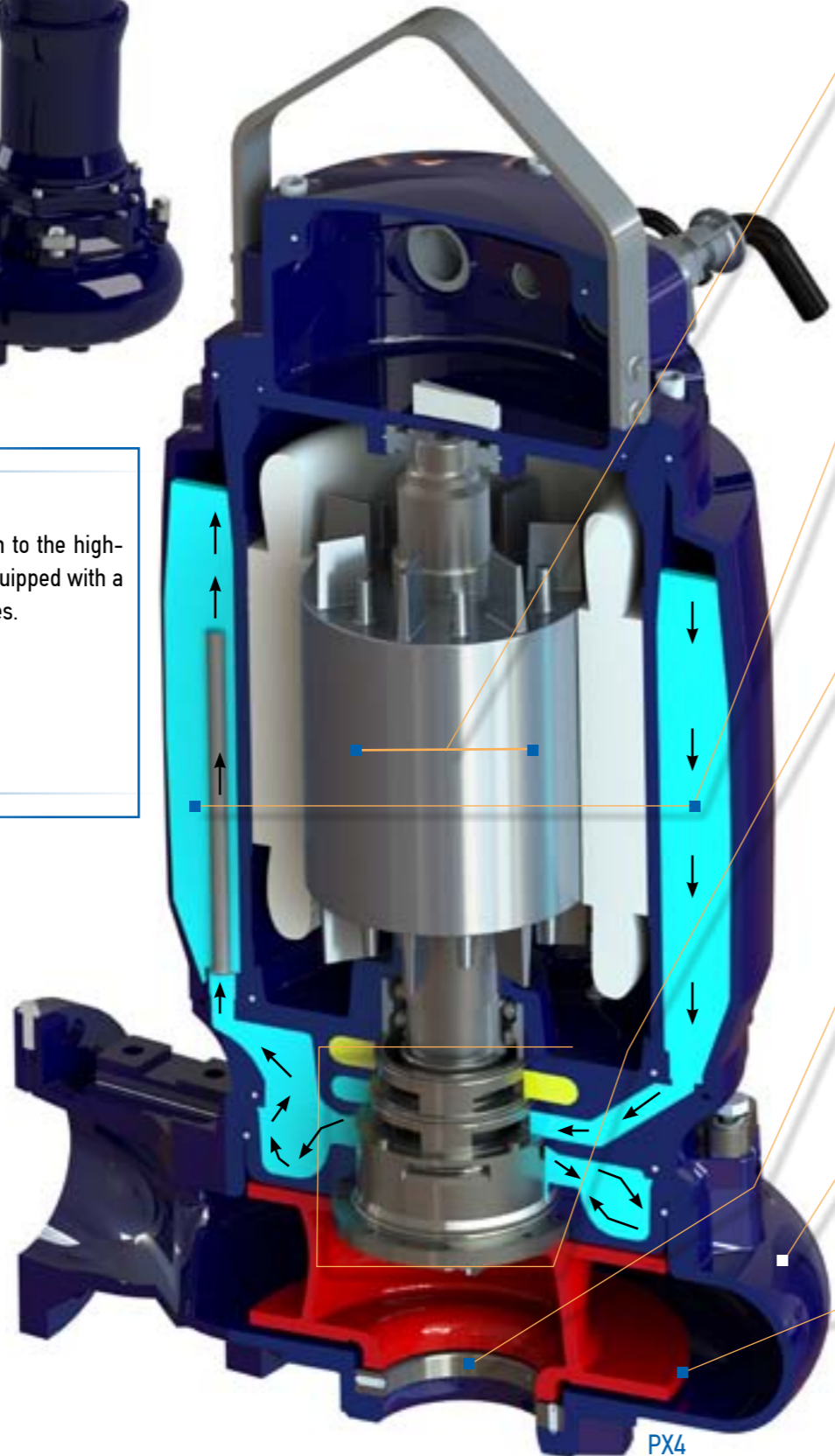

MOTOR UNIT*

The pumps are equipped with Siemens motor parts standard IE1 or IE2 (premium efficiency IE3 as option), are fitted with F class insulation, (for operating temperatures up to 155 degrees Celsius), or can be optionally fitted with H class insulation.

Three thermal overload switches, one per phase, are inside the winding, to combat high temperature loads. The oversized stainless steel rotor shaft and the two oversized ball bearings ensure the motor's smooth and vibration free rotation. Consequently the motor's operational life time is significantly extended.



INTERNAL MOTOR COOLING SYSTEM WITH "ECOFLU COOLING JACKET" *

All **PXFLOW** standard motor sizes are equipped with a closed cooling system. An internal impeller that is fitted in between the two mechanical shaft seals circulates the cooling liquid (ecoflu) in a closed loop inside a cooling jacket. The heat is then transferred to the pumped liquid by means of a cooling flange (heat exchange).

This efficient cooling system has the following great advantages:

- Maintains the optimal temperature range for the motor bearings.
- The cooling system is separated from the pumped liquid to eliminate any risk of clogging and sedimentation.
- The double sound absorbing pump motor casing, enables the unit to be running at an extremely low noise levels.

CARTRIDGE SEALING SYSTEM "FAST SEAL" *

The shaft system consists of a double set of mechanical seals that are built into a replaceable cartridge. The cartridge sealing system can be easily removed on site without the need of any special tools and thus eliminating the risk of any improper installation. The primary seal (impeller side) is made of abrasive resistant carbide against silicon carbide. The secondary seal (motor side) is made of heat resistant carbon against silicon carbide (option for PX1&2). Both mechanical seals incorporate a stainless steel shaft sleeve (316 as option) protecting the pump shaft. Every cartridge sealing system has been pressure tested at the factory regardless if it is being installed inside a **PXFLOW** pump or sold separately as spare parts.



CLEARANCE REDUCTION SYSTEM "REDUCER" *

The channel impellers are fitted with volute/impeller clearance reduction wear rings.

This system easily allows the ring to be repositioned axially in order to reduce the clearance between the channel impeller and the volute. This sealing method advantages over other methods which use radial impeller and volute wear rings that cannot be repositioned and have to be replaced when wear levels are not acceptable.

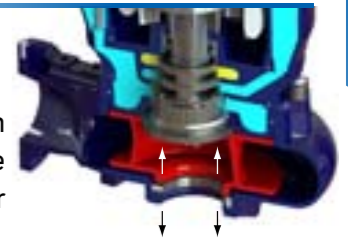

PUMP VOLUTES

The **PXFLOW** volutes are made from high quality cast iron and have been designed to have additional thickness on the walls. Extra attention has been given to the inside smoothed volute surfaces so higher hydraulic efficiency and minimum turbulence can be achieved. The volute is connected with the motor unit through a fast lock* connection system by means of stainless steel latch bolts for easy and fast removal. The motor unit can be quickly removed from the pump's volute for an easy inspection.



IMPELLERS

PXFLOW impellers are made from hardwearing ductile iron, (stainless steel 316 or DUPLEX as an option), and come in three types (single channel, multi channel and vortex) with a non clogging design that meets the pumping liquid needs and duty. The initial impeller design can be easily adjusted, (when trimmed), to meet the customer's performance requirements. **PXFLOW** impellers are dynamically balanced and machined to exacting tolerances to reduce any unwanted vibrations.



MOTOR PROTECTIONS

A. Moisture sensors

All PXFLOW pumps are equipped with two moisture sensors that are linked together in a series connection. Both sensors are connected to an electronic moisture monitoring system in order to effectively detect any increase in moisture inside the following areas:

- Terminal connection area (upper motor side).
- Inside the motor housing enclosure.
- Oil chamber of the sealing cartridge unit.

B. Motor winding Thermo-sensor

All PXFLOW pumps are equipped with thermo sensors to protect the stator from overheating and burning in the event of a motor malfunction. The thermal protection in the typical standard motor configuration consists of three bi-metals switches in series connection that are embedded in each respecting motor winding. Optionally we can offer with PTC or PT 100.

C. Bearing Thermo-sensors

In our largest pumps, (series PX3 & PX4 and above), the upper* and lower bearings housings can be equipped with the PT100 thermo sensors which provide the protection necessary against excessive temperatures.

*only for PX4 M4 series)

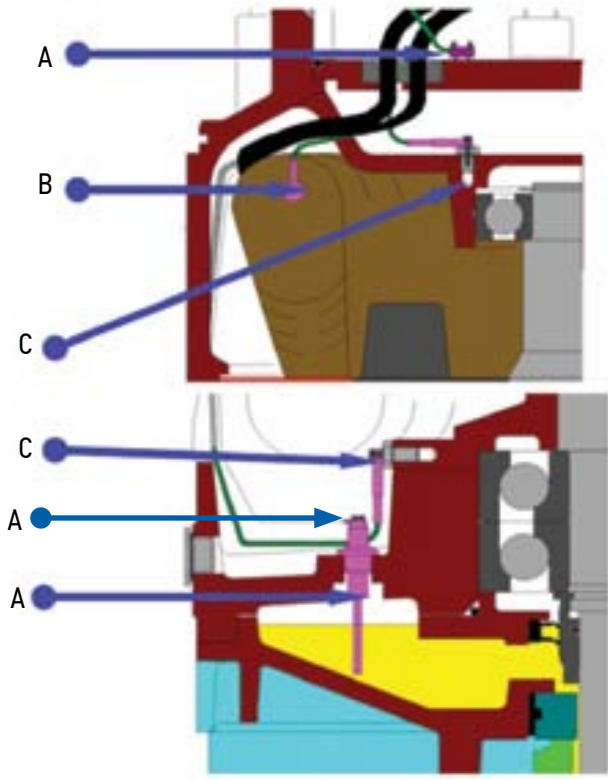

PX1, PX2



DESIGN FEATURES

- Internal motor cooling system with "ECOFLU" (closed loop through a cooling jacket)
- Cartridge sealing system "Fast Seal"
- Easily adjustable channel impeller clearance system "Reducer"*, for all installation types, for improved performance and less clogging occurrences
- Oil tap drain
- Free choice* channel or vortex impeller that can be fitted to the same volute
- Fast lock assembly/disassembly feature with only two latch bolts for quick and easy volute/impeller inspection (major advantage is the significant reduction of man-hours)
- Electrical motor PXFLOW - SIEMENS motor parts standard IE1 or higher efficiency IE2 (premium efficiency IE3 as option), have Class F insulation (rated for 155 degrees Celsius) as standard (Class H as option)
- Motor inspection hole
- Cable entry on the side of the pump cover
- Handle in Stainless steel

*PX1-83.0, PX2-80.0 is only available in the Vortex impeller design and has got no wear rings.

SERIES PX0, PX1-65 WITH VORTEX IMPELLER

The PX0 and Px1-65 pumps are made of cast iron and are equipped with a vortex impeller that is designed for pumping wastewater and other contaminated liquids.

The Px0 series, (single phase voltage configuration), is available with float switches and thermal protection or without them. The three phase voltage configuration can also be equipped with thermal protection upon the customer's request.

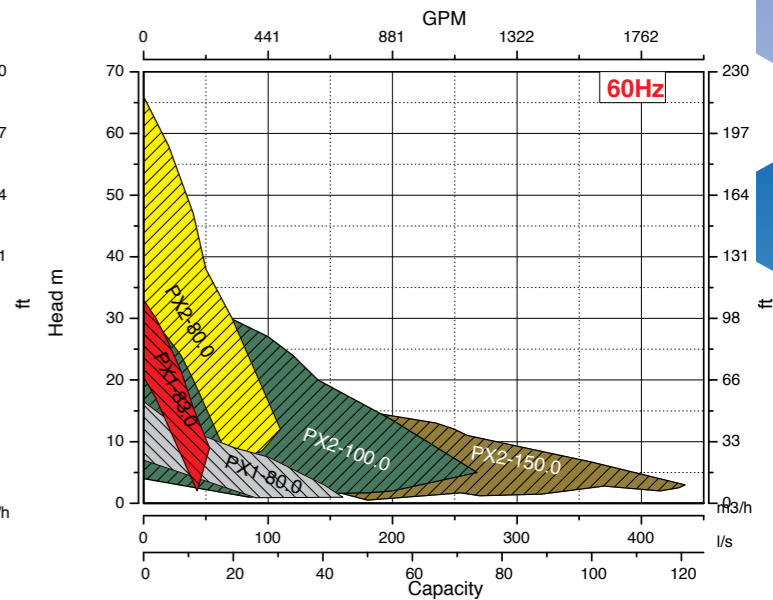
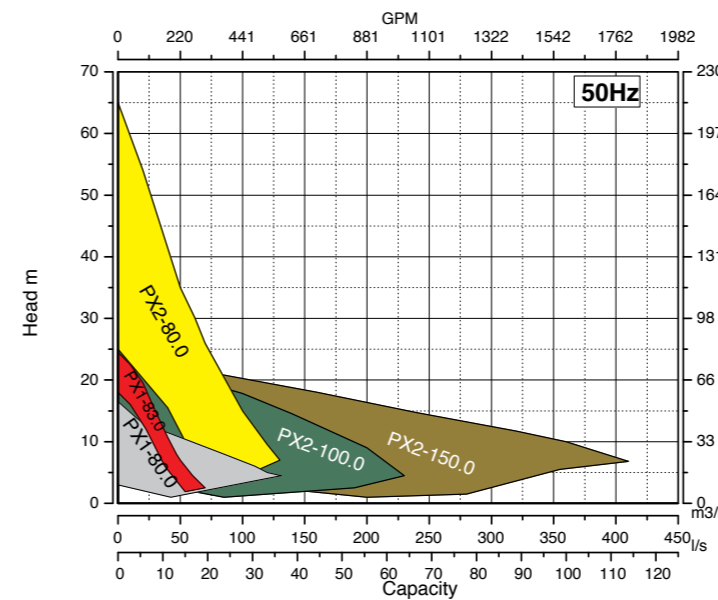
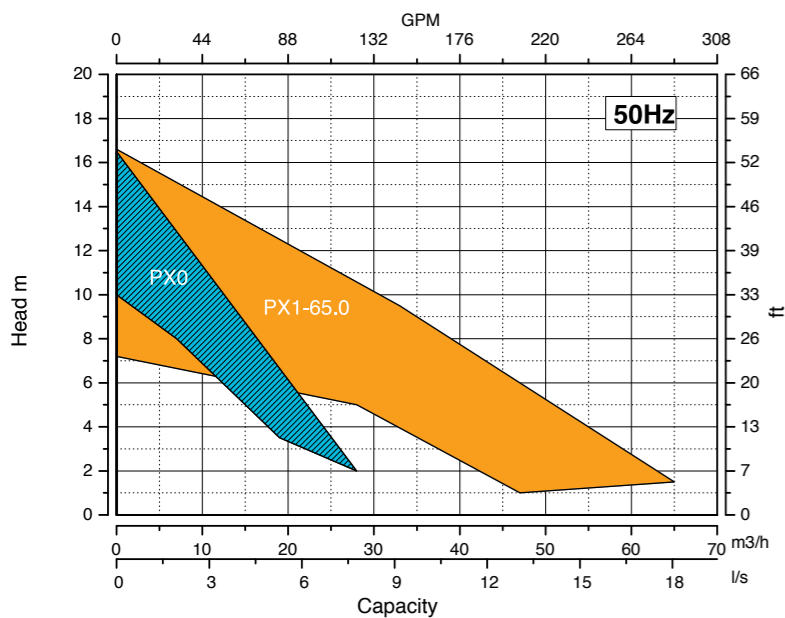

Model	PX1-80.0	PX1-83.0	PX2-80.0	PX2-100.0	PX2-150.0
Rating 50Hz	1,5-3,5 kW	4-5 kW	4-13,5 kW	3-15 kW	3-15 kW
Rating 60Hz	2,5-6 HP	6-7,5 HP	7,5-20 HP	4,6-25 HP	4,6-25 HP
Motor	4/6 pole	2 pole	2/4 pole	4/6 pole	4/6 pole
Pump outlet flange	80-100/3"-4"	65-80/2 1/2"-3"	80/3"	100/4"	150/6"
Pump inlet flange	80-100/3"-4"	100/4"	80/3"	100/4"	150/6"
Impeller types	channel / vortex	vortex	vortex	channel / vortex	channel / vortex
installation types available	wet/dry/portable	wet/dry/portable	wet/dry/portable	wet/dry/portable	wet/dry/portable

PX3

DESIGN FEATURES

- Internal motor cooling system with "ECOFLU" (closed loop through a cooling jacket)
- Cartridge sealing system "Fast Seal"
- Easily adjustable channel impeller clearance system "Reducer"*, for all installation types, for improved performance and less clogging occurrences
- Oil tap drain
- Free choice* channel or vortex impeller that can be fitted to the same volute
- Fast lock assembly/disassembly feature with only four latch bolts for quick and easy volute/impeller inspection (major advantage is the significant reduction of man-hours)
- Electrical motor **PXFLOW**-SIEMENS motor parts standard IE1 or higher efficiency IE2 (premium efficiency IE3 as option) have Class F insulation (rated for 155 degrees Celsius) as standard (Class H as option)
- Motor inspection hole
- Cable entry on the side of the pump cover
- Handle in Stainless steel

*PX3-80.0 is only available in the Vortex impeller design and has got no wear rings.



PX4

DESIGN FEATURES

- Internal motor cooling system with "ECOFLU" (closed loop through a cooling jacket)
- Cartridge sealing system "Fast Seal"
- Easily adjustable channel impeller clearance system "Reducer", for all installation types, for improved performance and less clogging occurrences
- Oil tap drain
- Free choice* channel or vortex impeller that can be fitted to the same volute
- Fast lock assembly/disassembly feature with only six latch bolts for quick and easy volute/impeller inspection (major advantage is the significant reduction of man-hours)
- Electrical motor **PXFLOW** - SIEMENS motor parts standard IE1 or higher efficiency IE2 (premium efficiency IE3 as option) have Class H insulation (rated for 180 degrees Celsius) as standard
- Motor inspection hole
- Cable entry on the side of the pump cover
- Handle in Stainless steel

*PX4-80.0 is only available in the Vortex impeller design and has got no wear rings.

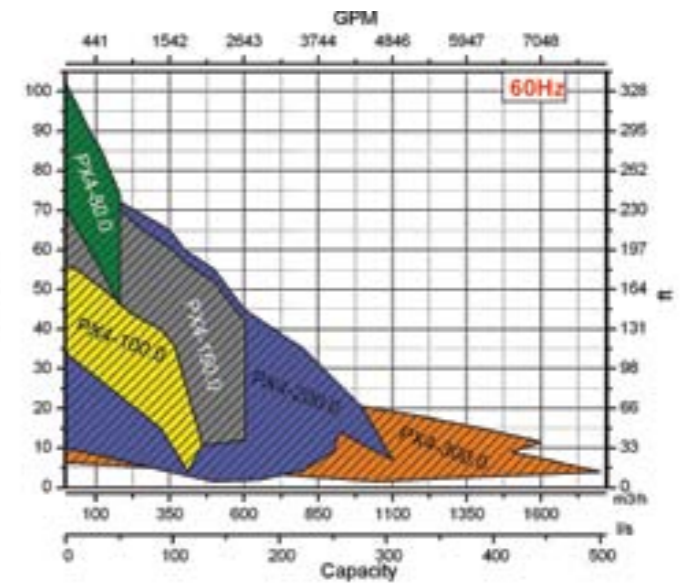
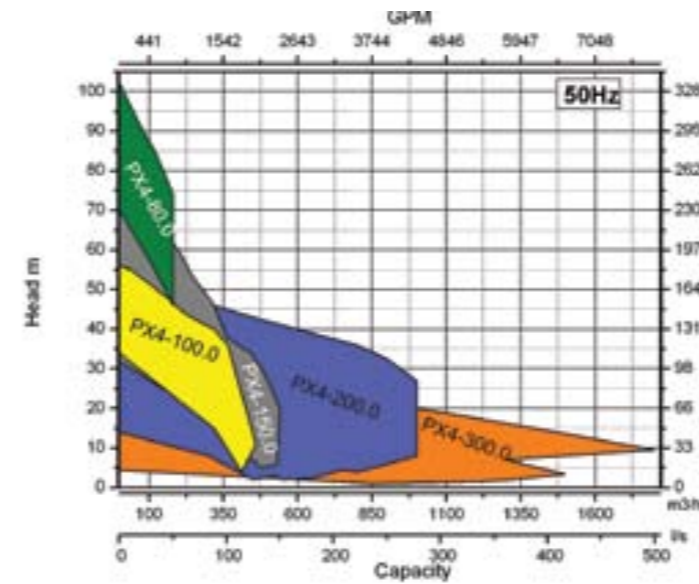
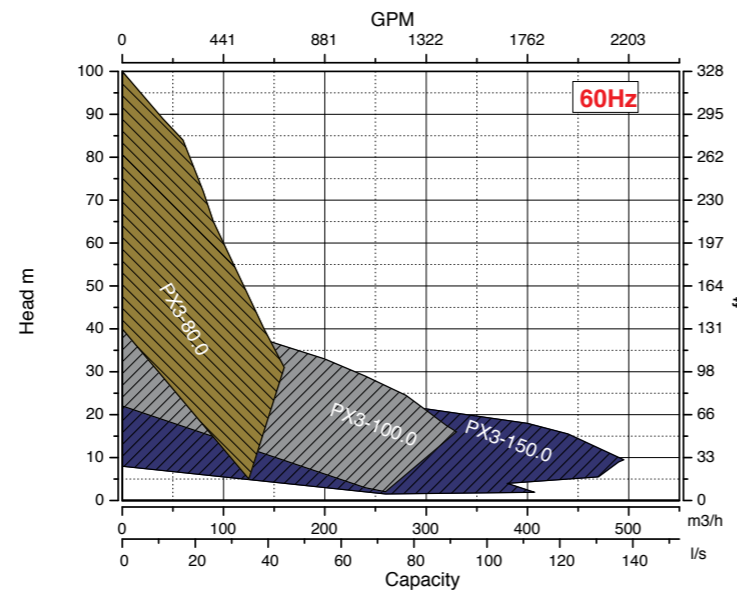
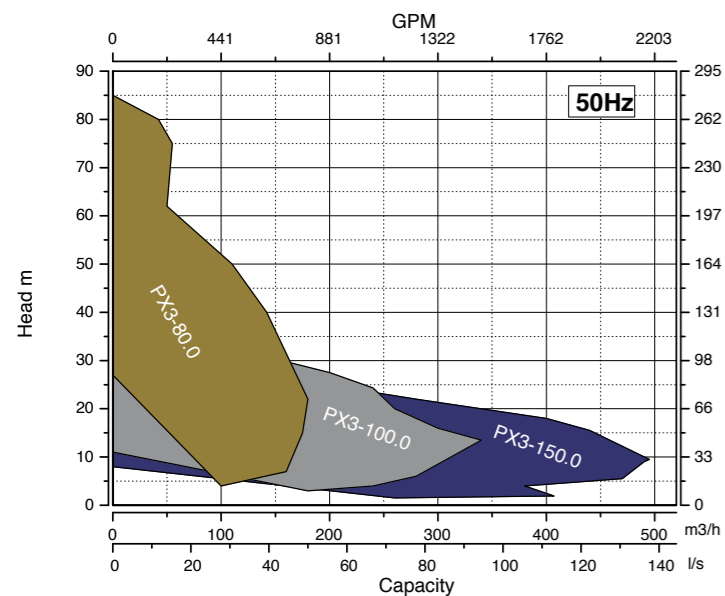

Model	PX3-80.0	PX3-100.0	PX3-150.0
Rating 50Hz	8-32kW	7.5-28kW	7.5-28kW
Rating 60Hz	19-46HP	15-40HP	15-40HP
Motor	2pole	4/6pole	4/6pole
Pump outlet flange	80-100/3"-4"	100/4"	150/6"
Pump inlet flange	80-100/3"-4"	100/4"	150/6"
Impeller types	vortex	channel / vortex	channel/vortex
installation types available	wet/dry/portable	wet/dry/portable	wet/dry/portable

Model	PX4-80.0	PX4-100.0	PX4-150.0	PX4-200.0	PX4-250.0	PX4-300.0
Rating 50Hz	37-93 kW	37-93 kW	22-115 kW	22-115 kW	22-115 kW	22-115 kW
Rating 60Hz	46-125 HP	46-125 HP	15-180 HP	15-180 HP	15-180 HP	15-180 HP
Motor	2 pole	4 pole	2/4 pole	4/6/8 pole	4/6/8 pole	4/6/8 pole
Pump outlet flange	80-100/3"-4"	100/4"	150/6"	200/8"	250/10"	300/12"
Pump inlet flange	80-100/3"-4"	100/4"	150/6"	200/8"	250/10"	300/12"
Impeller types	vortex	channel / vortex	channel / vortex	channel / vortex	channel / vortex	channel
installation types available	wet/dry/portable	wet/dry/portable	wet/dry/portable	wet/dry/portable	wet/dry/portable	wet/dry/portable

GRINDER PUMPS

The **PXGRIND** pumps are equipped with a grinding system that effectively reduces all destructible solid pieces and fibrous materials, such as paper, textile, plastics, etc into small particles so they can be led away through pipes of relatively small diameter.

DESIGN FEATURES

- Stainless steel cutter system
- Internal motor cooling system with "ECOFLU " (closed loop through a cooling jacket)
- Cartridge sealing system " Fast Seal "
- Easily adjustable channel impeller clearance system "Reducer" for improved performance and less clogging occurrences
- Oil tap drain
- Ductile multi channel impeller
- Fast lock assembly/disassembly feature with only two latch bolts for quick and easy volute/impeller inspection (major advantage is the significant reduction of man-hours)
- **PXFLOW** - SIEMENS motor parts standard IE1 or higher efficiency IE2 (premium efficiency IE3 as option)
- Motor inspection hole
- Cable entry on the side of the pump cover
- Handle in Stainless steel

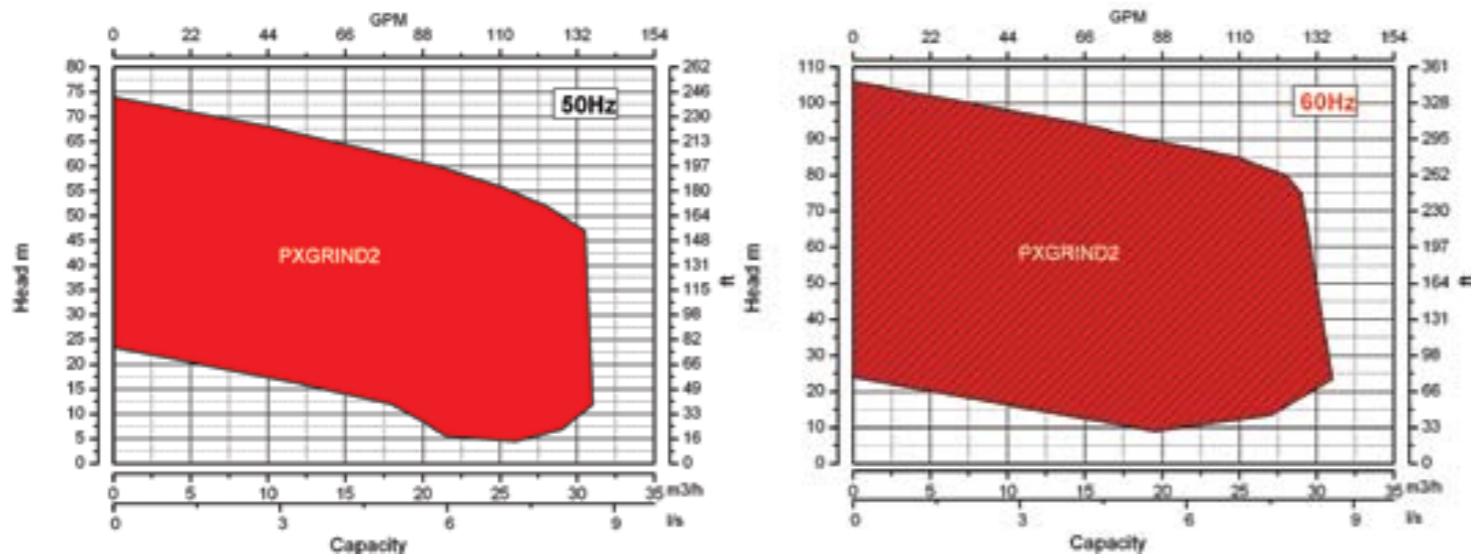

Model	PXGRIND2
Rating 50Hz	6.5-13.5 kW
Rating 60Hz	10-20 HP
Motor	2/4 pole
Pump outlet flange	50/2"
Pump inlet flange	Grinder
Impeller types	Channel
installation types available	wet/portable



TYPES OF INSTALLATION

A. Wet type installation

The self guiding coupling system allows for the quick and efficient pump unit inspection. The elbow shaped stationary Discharge Connection Bracket (DCB) is securely fastened at the bottom of the sump. The pump's discharge outlet is perfectly aligned with the DCB's opening and the connection is maintained sealed by the pump's own weight.

B. Dry type installation

In this case a **PXFLOW** pump, equipped with the ECOFLU (internal motor cooling system), is installed in a separate pump chamber. All piping is bolted directly to the pump volute (suction and discharge end). The fast lock connection system permits the fast motor unit and impeller removal from the pump's volute for an easy and friendly inspection. These pumps can replace old existing pumps with dry motors and can still remain operational even if there still water inside the pump chamber.

C. Transportable installation

This type of submersible pump is equipped with a suction stand that comes with or without a strainer. This portable pump unit can be an excellent solution for dewatering construction sites especially when equipped with the ECOFLU cooling system.

SERVICE ADVANTAGES

Discharge flange connection and adapter designed for quick and easy replacement of other pumps brand. **PXFLOW** pumps, depending the replacement brand, can use **PXFLOW** adapter or the existing flange adapter and can be installed on existing base elbow which stays in wet well with their guide rails systems.



At Papantonatos S.A. we are proud to claim that our Flowpap and PXflow pumps, for clean water and waste water applications respectively, have earned us the credential of being one of the fastest growing submersible pump manufacturers in South Eastern Europe. Our large network of distributors and service specialists in the Americas, Europe, Asia Pacific and the Middle East is growing very rapidly. Look for one of our specialists to a location near you and let our team of technical and engineering support professionals to answer any technical question and solve any new issues that your company may encounter.

Please contact us to learn about the location of a sales and service point near you



FACTORY - HEAD OFFICE:

Athens-Greece

Roumelis & Kapetan Zacharia 1 (ex. Afon Ntouna)

P.O. Box 46546, 13677 Acharnes Attiki

Tel: (+30) 2102431111, FAX: (+30) 2102431601

e-mail: sales@papantonatos.gr

www.papantonatos.gr

